

KINGSMITH WalkingPad Treadmill User Manual

Please read this manual carefully before using and then keep it properly.



Manufacture: Beijing KINGSMITH Technology Co., Ltd.

Add.: 410, inner 4/F, 101, 1-15/F, Bldg. 25, Zone 18, South Fourth Ring West Rd., Fengtai Dist., Beijing.

After -sale Services Email: support@walkingpad.com

MADE IN CHINA

TRR1F

WARNING

1. This appliance can be used by children aged from 8 years and above and persons with reduced physical, sensory or mental capabilities or lack of experience and knowledge if they have been given supervision or instruction concerning use of the appliance in a safe way and understand the hazards involved. Children shall not play with the appliance. Cleaning and user maintenance shall not be made by children without supervision.
2. Correct Disposal of this product. This marking indicates that this product should not be disposed with other household wastes throughout the EU. To prevent possible harm to the environment or human health from uncontrolled waste disposal, recycle it responsibly to promote the sustainable reuse of material resources. To return your used device, please use the return and collection systems or contact the retailer where the product was purchased. They can take this product for environmental safe recycling.

This appliance is not intended for use by persons (including children) with reduced physical, sensory or mental capabilities, or lack of experience and knowledge, unless they have been given supervision or instruction concerning use of the appliance by a person responsible for their safety.

Children should be supervised to ensure that they do not play with the appliance.

WARNING: keep young children away from this machine at all times. Contact with the moving surface may result in severe friction burns.

01. Product and Accessories	02
02. Function Diagram	03
03. Initial Operating Guide	07
04. Learn to Use the Treadmill	09
05. Trademark and Legal Notice	12
06. Safety Instruction	13
07. Maintenance and Repair	16

Welcome

Thank you for choosing KINGSMITH WalkingPad Treadmill, and hereinafter referred to as “Treadmill”. The exquisite, simple and innovative design enable you to enjoy your quality and enjoyable workout at home. This Treadmill is designed for family use only. Please do not use it for any business, lease or public group purpose.

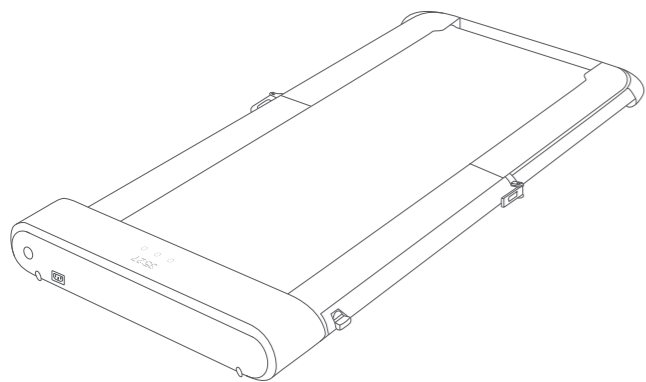

Preference Index	Parameter
Applicable Age	14-60 years old
Speed Range	0.5-10 km/h (Max speed under walking pattern: 6km/h)
Running Area	440×1200 mm
Max Load	110 kg
Frequency	50/60 Hz
Voltage	220-240 V~
Power Input	918 W
Net Weight	33 kg
Gross Weight	38 kg
Unfold Size	1460×720×900 mm
Folded Size	980×720×155 mm
Motor Pattern	Running Mode/Walking Mode

01. Product and Accessories

Please check if the items inside the packaging box are complete and intact. In case of any missing or breakage, please contact us by email support@walkingpad.com

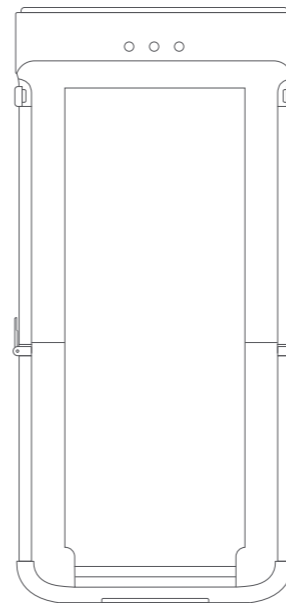

Treadmill

Accessories



Power line



Remote control



Remote control lanyard



Hex L Shaped Wrench



Safe Lock



Silicone Oil

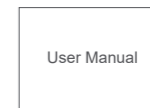

User Manual

02. Function Diagram

1. Walking Mode

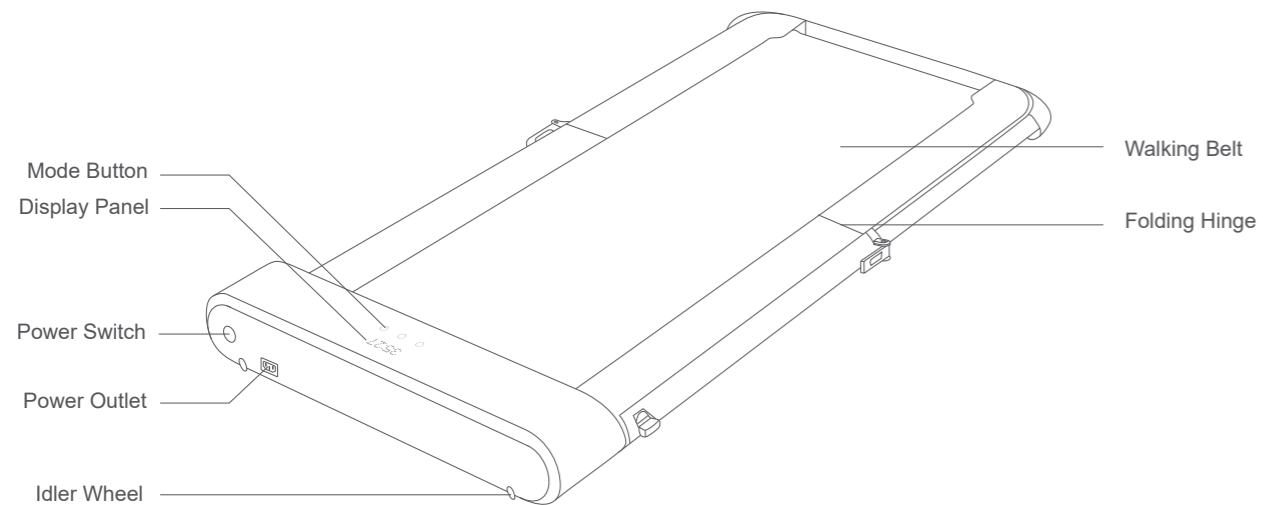

2. Running Mode

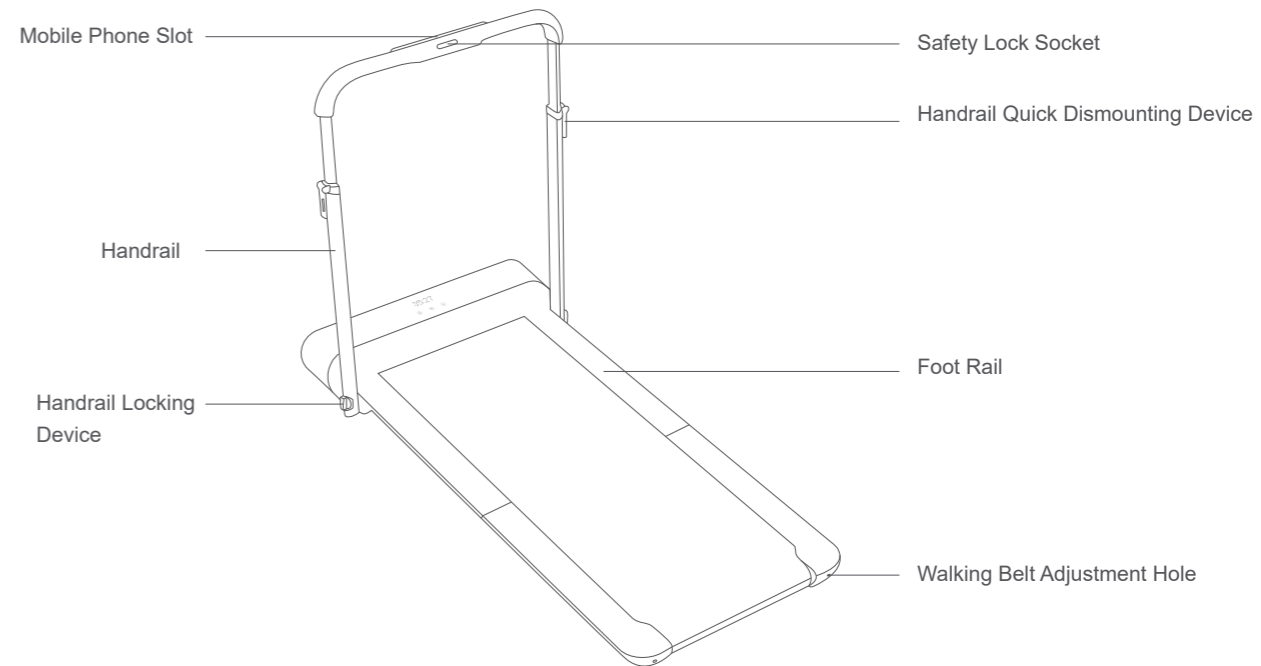

02. Function Diagram

3. Display Panel Function Introduction

TIME KM SPD STEP CAL

Time

Distance

Speed

Steps

Calorie

Steps and Calorie data can be displayed on the panel after being set in the APP.

Touch Key-press



Standby Mode



Manual Mode



Automatic Mode

Indicator Light



Fault Caution Light



Connection Caution Light

4. Remote Control

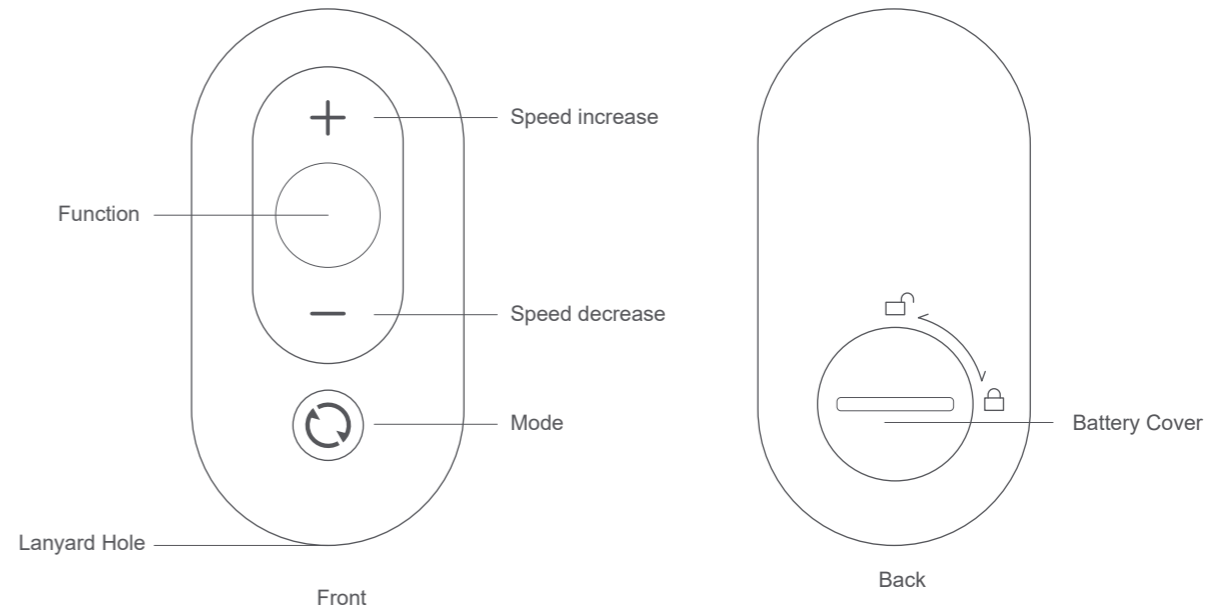

03. Initial Operating Guide

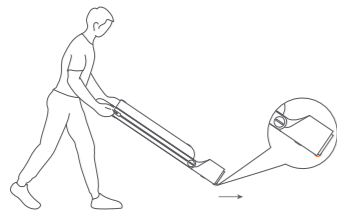

1. When pushing and pulling, please ensure that the handrail has shrunk to a minimum and fix the handrail locking and quick dismounting device. Put it on a flat floor, please don't put it on too soft cushion or thick carpet.

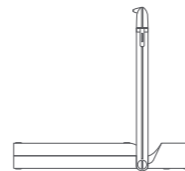

2. Loosen the handrail locking device, lift the handrail to a vertical angle, and tighten the handrail locking device.

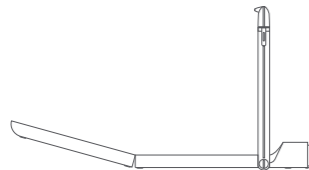

3. Unfold the treadmill, adjust the walking belt to the center position, slowly unfold it and assist in pressing it down to make it completely flat, or rotate the bottom foot cushion for leveling.

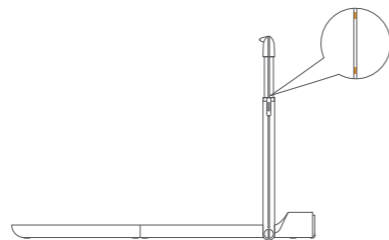

4. Adjust the handrail quick mounting device to a suitable height, and then lock the device. Yellow marks on the handrail sides indicate the recommended maximum and minimum heights.

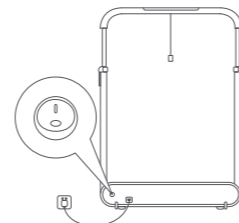

5. Install safety switch, connect power supply and turn on.

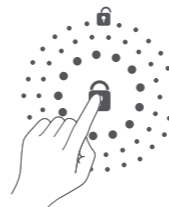

7. Open APP, follow the prompts to add and bind the treadmill for use.

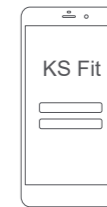

6. Download "KS Fit" APP from Apple Store or Google Play Store and complete installation.

04. Learn to Use the Treadmill

1. Mode Description



Standby Mode

The standby mode indicator lights up, the motor and sensor stop responding.



Manual Mode

The manual mode indicator lights up, control the speed via remote control or APP.



Automatic Mode

The automatic mode indicator lights up, control the speed automatically via intelligent algorithm.

2. Standby Mode Control Description



Standby Mode

Under standby mode, users can press the mode button on the remote control briefly to wake up the treadmill and switch to the default manual mode state.

Users can also touch the standby icon on the display panel to wake up the treadmill.

When the treadmill is not running, press the mode button on the remote control or touch the standby icon on the display panel to switch to the standby mode.

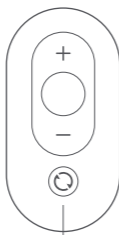

Remote Control Legend

Short press: Mode switch

Long press: Switch to standby mode (non-operational state)

3. Manual Mode Control Description(primary mode)



Manual Mode

In this mode, users can use the remote control to control the treadmill. Beginners are advised to use the manual mode first, and then use the automatic mode after being skilled in using it.

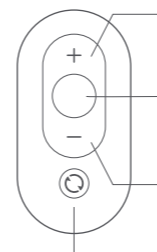

Speed Increase Button

Short press: Speed increased by 0.5km/h

Function Button

Short press: Boot or stop the treadmill

Speed Decrease Button

Short press: Speed decreased by 0.5km/h

Mode Button

Short press: Mode switch

Long press: Switch to standby mode (non-operational state)

04. Learn to Use the Treadmill

4. Automatic Control Mode Description(progressive mode)



Automatic

This mode is an progressive mode, which is difficult to control and can be used completely without the remote control. It is advised to use the mode after proficiency.

Use the remote control to start and stop, and the mode switch button is effective under this mode.

Note: The automatic control mode can only available under walking mode.

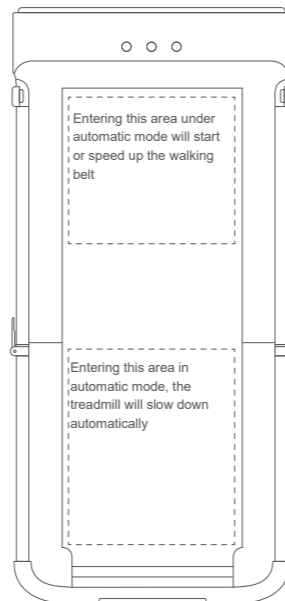

05. Trademark and Legal Notice

5. Remote Control Paring Instructions

If the remote control does not respond or you have replaced the remote control, you need to re-pair.

Pairing method: Restart the machine and press the mode button on the remote control for 5 seconds.

6. Connection Caution Light

Not connected to APP: Flicker

Connected to APP: Off

7. Fault Caution Light

E01: Software overcurrent

E02: Hardware overcurrent

E03: IPM Module Overheating

E04: Low-voltage Protection

E05: Overvoltage Protection

E06: Motor phase loss protection

E07: Motor block rotation protection

E08: Sensor fault

E09: Motor unable to start

E12: Motor overcurrent

protection

E13: Overloading protection

E14: Hall signal loss

E15: Communication fault

The patents involved in Kingsmith WalkingPad Treadmill series products are made by Beijing Kingsmith Technology Co., Ltd. and owned by the Company. No organization or individual may copy, distribute all or any part of this manual without Kingsmith's written permission, and may not use these patents without authorization.

When printing this manual, we have put various functional descriptions and instructions in it as far as possible.

However, due to the continuous improvement of product functions and design changes, there may still be discrepancies with the products you purchased. Due to product update, this manual may deviate from the actual product in terms of color, appearance, etc. Please refer to the actual product.

06. Safety Instruction

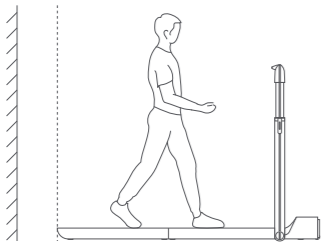

- !** The space distance behind the treadmill should be kept above 2000 mm. In case of emergency, you can hold the handrail tightly with both hands and support your body to jump off the treadmill.

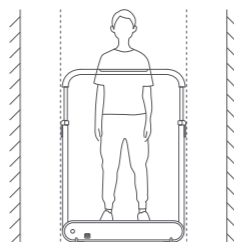

- !** The distance between the two sides of the treadmill should be kept above 500mm.

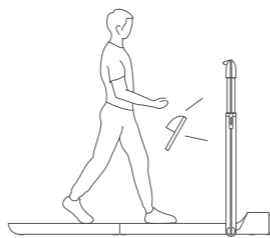

- !** Do not wear loose or dangling clothing while using the treadmill, you should wear sports shoes and clothes. Please exercise according to your own situation. If you feel uncomfortable during the workout, please stop immediately and consult a doctor. Otherwise, you may be at risk of injury.

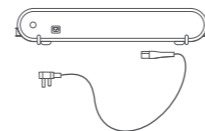

- !** Please unplug the power cord when not in use.

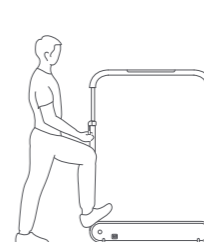

- ⊗** Do not step on the head of the treadmill.

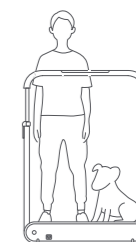

- ⊗** Do not bring pets when using.

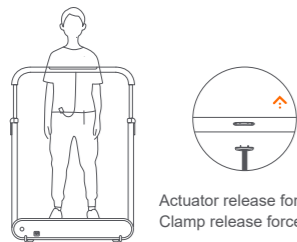

Actuator release force: 7N
Clamp release force: 18N

- !** Read, understand, and test the emergency stop procedures before use. When using, please clamp the other end of the safe lock on clothes. If there is an unexpected situation, pull off the safety lock to stop the treadmill immediately.

Start to use the treadmill.

Noisy level is 65dB(A).

The treadmill has an emergency stop mechanism for your safety. Before starting your training, attach the safety key to your clothing. If the treadmill was switched off due to the safety key being pulled out, insert it again. The continuous belt does not start up again automatically.

Uncontrolled use of the treadmill by a third party can be avoided by taking the safety key off and storing it in a secure place.

In an emergency, hold the handrails tightly with both hands and step off of the belt onto the side surfaces of the side platforms. Activate the emergency stop mechanism (safety disconnect).

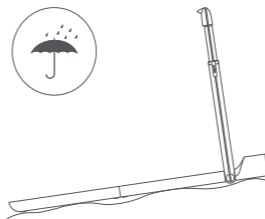

- ⊗** Do not operate electrically powered treadmills in damp or wet locations. Do not use it on an irregular ground.

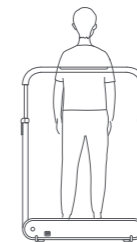

- ⊗** Do not use the treadmill upside down or sideways.

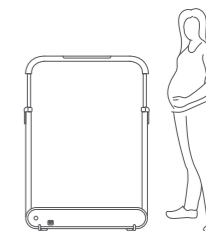

- !** Use with caution for the elderly, children and pregnant women.

06. Safety Instruction

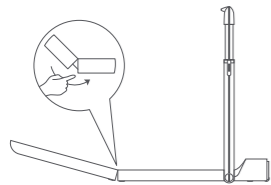

⚠ Watch your hands.

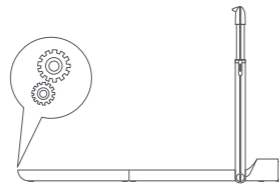

⚠ Take care of your belongings.

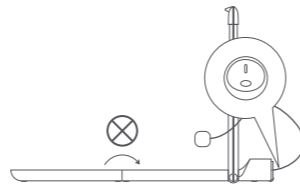

⊗ Do not fold before power off.

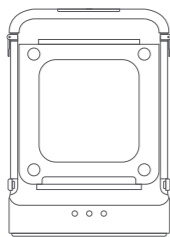

⚠ Keep treadmill upright and put it in the space with supporting points on both sides as far as possible, please stay away from children.

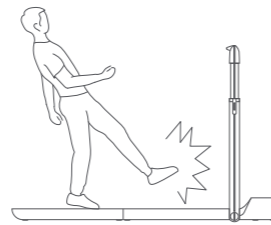

⊗ Do not get on and off the machine under running condition.

07. Manutenzione

1. Clean the treadmill

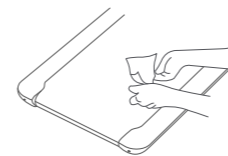

- Disconnect all power before servicing the treadmill.
- Add a little mild detergent to the 100% cotton cloth. Do not spray the detergent directly on the walking belt or use acidic and corrosive detergent.
- Do not wipe under the walking belt
- After a period of exercise, dust and stains may appear on the rear floor. This is normal and just wipe.

2. Walking Belt Slipping and Correction

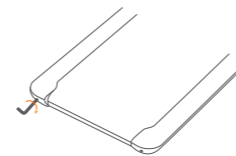

- Start the treadmill and run at a speed of 3 km/h.
- Walking belt to the left: Turn the left adjusting hole screw clockwise by 1/4 turn.
- Walking belt to the right: Turn the right adjusting hole screw clockwise by 1/4 turn.
- Walking belt slipping: Turn the left and right adjusting screws clockwise for 1/2 turn at the same time.
- After each adjustment, it needs to run for a period of time (1-2 minutes) to observe the correction. Please adjust again if necessary.

3. Walking belt lubrication

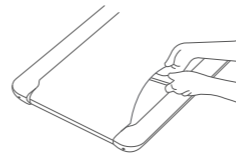

- Power off the treadmill and unplug the power cord
- Lift the edge of the walking belt and smear the inner surface with silicone oil.
- Start the treadmill to run at a speed of 3km/h for 10-20 seconds.
- 5-10ml of silicone oil is required for one lubrication. Excessive application may cause slipping and affect normal use.
- Lubricate your walking belt every three months.